



Model 5103 Installation Guide

This product is intended for installation by a professional installer only! Attempts to install this product by a person other than a trained professional may result in severe damage to a vehicle's electrical system and components.

Directed[®]
E L E C T R O N I C S

© 2009 Directed Electronics, Vista, CA
N5103L 2009-07

Bitwriter®, Code Hopping™, Doubleguard®, ESP2™, FailSafe®, Ghost Switch™, Learn Routine™, Nite-Lite®, Nuisance Prevention® Circuitry, Revenger®, Silent Mode™, Soft Chirp®, Stinger®, Valet®, Vehicle Recovery System®, VRS®, and Warn Away® are all Trademarks or Registered Trademarks of Directed Electronics.



The Bitwriter® (p/n 998U) requires chip version 2.7 or newer to program this unit.

Bitwriters with date code of 6A or older require an IC upgrade (p/n 998M). Some Bitwriters with a date code of 6B do not require the IC upgrade. Refer to Tech Tip # 1112 for more information



Contents

Warning! Safety first	5
What is included.....	7
Installation points to remember	8
Virtual tach	8
D2D.....	8
Before beginning the installation	9
After the installation	9
Component locations and finding wires	10
Valet/program switch.....	10
Status LED.....	11
Making your wiring connections	12
Primary harness (H1), 12-pin connector.....	13
Auxiliary harness (H2), 6-pin connector.....	13
Door lock harness, 3-pin connector	13
Remote start ribbon harness, wiring diagram	14
Heavy gauge relay satellite wiring diagram	14
Relay satellite 4-pin connector	14
Remote start harness, (H3) 5-pin connector	15
AUX 4, Horn, (H4), 2-pin connector	15
Wire connection guides	15
Primary harness (H1), 12-pin connector.....	15
Auxiliary harness (H2), 6-pin connector.....	21
Relay satellite 4-pin connector	26
Remote start, (H3) secondary harness	27
AUX 4, Horn, (H4) 2-pin connector.....	29
Neutral safety switch interface	30
Testing the neutral safety switch	30
Plug-in LED and valet/program switch.....	31
D2D programmer interface - 4-pin red plug	31
Shock sensor harness, 4-pin connector.....	32
Tachometer settings	33
Virtual tach	33
Tach learning	34
Programming jumpers.....	35
Tach threshold On/Off	35
Light flash (+) / (-) polarity	35
Transmitter/receiver Learn Routine™.....	36
Transmitter configurations.....	39
Standard configuration.....	39
Multi-level security arming	40
System features learn routine	41

Feature menus	43
Menu 1 - Basic	43
Menu 2 - Advanced	44
Menu 3 - Remote start	45
Feature descriptions.....	46
Menu 1 - Basic	46
Menu 2 - Advanced	49
Menu 3 - Remote start	52
NPC, Valet Mode, Rear defogger, Timer Mode	54
Table of zones	55
Long term event history	56
Shutdown diagnostics	57
Safety check	58
Troubleshooting	59
Alarm	59
Remote start	60
Wiring quick reference guide	62
Relay satellite wiring quick reference guide	63

Warning! Safety first

The following safety warnings must be observed at all times:

- Due to the complexity of this system, installation of this product must only be performed by an authorized Directed Electronics dealer.
- When properly installed, this system can start the vehicle via a command signal from the remote control. Therefore, never operate the system in an area that does not have adequate ventilation.

The following precautions are the sole responsibility of the user; however, authorized Directed Electronics dealers should:

- **Never use a test light or logic probe when installing this unit. Always use a multimeter.**
- Never operate the system in an enclosed or partially enclosed area without ventilation (such as a garage).
- When parking in an enclosed or partially enclosed area or when having the vehicle serviced, the remote start system must be disabled using the installed toggle switch. It is the user's sole responsibility to properly handle and keep out of reach from children all remote controls to assure that the system does not unintentionally remote start the vehicle.

USER MUST INSTALL A CARBON MONOXIDE DETECTOR IN OR ABOUT THE LIVING AREA ADJACENT TO THE VEHICLE. ALL DOORS LEADING FROM ADJACENT LIVING AREAS TO THE ENCLOSED OR PARTIALLY ENCLOSED VEHICLE STORAGE AREA MUST REMAIN CLOSED AT ALL TIMES.

Use of this product in a manner contrary to its intended mode of operation may result in property damage, personal injury, or death. Except when performing the Safety Check outlined in this installation guide, (1) Never remotely start the vehicle with the vehicle in gear, and (2) Never remotely start the vehicle with the keys in the ignition. The user will be responsible for having the neutral safety feature of the vehicle periodically checked, wherein the vehicle must not remotely start while the car is in gear. This testing should be performed by an authorized Directed Electronics dealer in accordance with the Safety Check outlined in this product installation guide. If the vehicle starts in gear, cease remote start operation immediately and consult with the user to fix the problem immediately. After the remote start module has been installed, test the remote start module in accordance with the Safety Check outlined in this installation guide. If the

vehicle starts when performing the Neutral Safety Shutdown Circuit test, the remote start unit has not been properly installed. The remote start module must be removed or properly reinstalled so that the vehicle does not start in gear. All installations must be performed by an authorized Directed Electronics dealer.

OPERATION OF THE REMOTE START MODULE IF THE VEHICLE STARTS IN GEAR IS CONTRARY TO ITS INTENDED MODE OF OPERATION. OPERATING THE REMOTE START SYSTEM UNDER THESE CONDITIONS MAY RESULT IN PROPERTY DAMAGE OR PERSONAL INJURY. IMMEDIATELY CEASE THE USE OF THE UNIT AND REPAIR OR DISCONNECT THE INSTALLED REMOTE START MODULE. DIRECTED ELECTRONICS, INC. WILL NOT BE HELD RESPONSIBLE OR PAY FOR INSTALLATION OR REINSTALLATION COSTS.

What is included

- The control module (see diagram)
- HX antenna receiver
- Two remote controls (P/N 474L)
- A Stinger™ Doubleguard® two - stage shock sensor
- A Revenger™ Soft Chirp™ six tone programmable siren
- A push-button Valet® switch
- A status LED indicator light
- A shut-down toggle switch

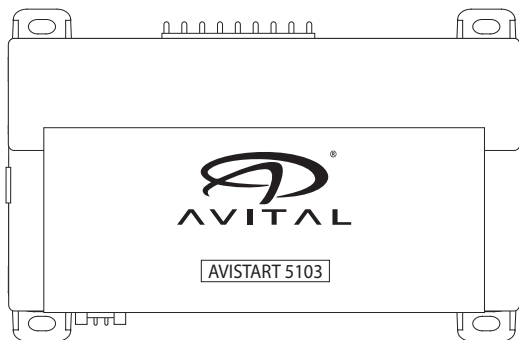

Installation points to remember

This product is designed for fuel-injected, automatic transmission vehicles only. Installing it in a standard transmission vehicle is dangerous and is contrary to its intended use.

➤ Virtual tach

Virtual Tach is the default RPM-sensing method for the new remote start systems. Virtual Tach gives the installer the performance of a hard wired tach wire, with the convenience of voltage sensing. It is far superior to any voltage-sense feature you've tried before.

Virtual Tach monitors the cranking voltage of the vehicle using a very fast micro controller and an analog-to-digital converter. The microprocessor "saves" the base voltage as a reference. When Virtual Tach "sees" the slightest uptick in voltage, indicating that the alternator is charging the battery, the starter motor shuts off instantly.

➤ D2D

The system has the ability to interface with an Xpresskit module through the D2D port. The advantage to using a D2D interface is that there is less wiring involved in the installation. Check the Xpresskit module installation guide to determine which wires are not needed, and which options are available. For more information visit www.xpresskit.com.

➤ Before beginning the installation

- Please read this entire installation guide before beginning the installation. The installation of this remote start system requires interfacing with many of the vehicle's systems. Many new vehicles use low-voltage or multiplexed systems that can be damaged by low resistance testing devices, such as test lights and logic probes (computer safe test lights). Test all circuits with a high quality digital multi-meter before making connections.
- Do not disconnect the battery if the vehicle has an anti-theft-coded radio. If equipped with an air bag, avoid disconnecting the battery if possible. Many airbag systems display a diagnostic code through the warning lights after the lights lose power. Disconnecting the battery causes the anti-theft code to be erased, which can then require a trip to the dealer.
- Before mounting the LED or Valet Switch, check with the customer about the mounting locations.
- To avoid accidental battery drainage; turn off the interior lights or remove the dome light fuse.
- Roll down a window to avoid being locked out of the car.

➤ After the installation

- Test all functions. The Using Your System section of the Owner's Guide is very helpful when testing.
- When testing, don't forget that this system is equipped with Nuisance Prevention® Circuitry (NPC). NPC can bypass trigger zones, making them appear to stop working. See the Nuisance Prevention® Circuitry section of the Owner's Guide.
- Review and complete the Safety Check section of this guide prior to the vehicle reassembly.

Component locations and finding wires

For detailed information on where to locate components, and how to find the wires you need, please refer to the Direct Tech web site at www.directechs.com.

► Valet/program switch

IMPORTANT! When the vehicle is delivered, please show the user where this switch is located and how to disarm the system with it.

Ensure that the location you pick for the switch has sufficient clearance to the rear. The switch should be well hidden. It should be placed so passengers or stored items (such as in a glove box or center console) cannot accidentally hit it. The switch fits into a 9/32-inch hole.

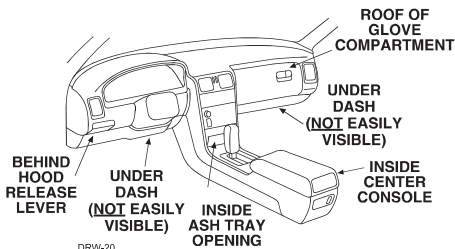

This system has Remote Valet. The user can enter and exit Valet Mode without having to use the Valet/Program switch. This feature was introduced so that switch location was less critical in day-to-day use. As long as the Valet/Program switch can be reached to disarm without a transmitter, easy access is not important.

► Status LED

Things to remember when positioning the Status LED:

- It should be visible from both sides and the rear of the vehicle, if possible.
- It needs at least 1/2-inch clearance to the rear.
- It is easiest to remove a small panel, such as a switch blank or a dash bezel, before drilling a 9/32-inch hole.
- Use quick-disconnects near the LED wires if the panel is removable. This lets mechanics or other installers remove the panel without cutting the wires.

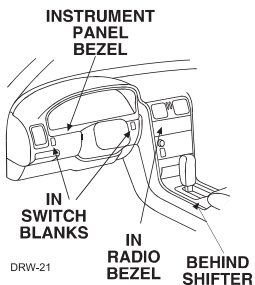

Making your wiring connections

Before making your connections, plan how your wires will be routed through the vehicle. For instance, the red 12V constant input and the remote start ignition wires are often routed together to the ignition switch harness. In order to keep the wiring neat and make it harder to find, you may wish to wrap these wires together in electrical tape or conceal them in tubing similar to what the manufacturer used.

There are two acceptable ways of making a wire connection - solder connections and crimp connectors. When properly performed, either type of connection is reliable and trouble-free. Regardless of whether you solder your connections or you use mechanical type crimp-on connections, ensure that all connections are mechanically sound and that they are insulated, especially when connecting data lines in the vehicle.

Cheap electrical tape, especially when poorly applied, is not a reliable insulator. It often falls off in hot weather. Use good quality electrical tape or heat shrink.

- Never twist-and-tape the wires together without soldering.
- Never use "fuse taps", as they can damage fuse box terminals.

If you use tapping connectors such as T-Taps (not to be confused with Scotch-Locks), avoid using them in higher-current applications (constant 12V, ground, etc.) These connectors are inferior in quality and should be avoided.

➤ Primary harness (H1), 12-pin connector

H1/1	RED/WHITE	(-) 200mA AUX TRUNK RELEASE OUTPUT
H1/2	RED	(+) CONSTANT POWER INPUT
H1/3	BROWN	(+) SIREN OUTPUT
H1/4	EMPTY	NOT USED
H1/5	BLACK	(-) CHASSIS GROUND INPUT
H1/6	VIOLET	(+) DOOR TRIGGER INPUT, ZONE 3
H1/7	BLUE	(-) INSTANT TRIGGER INPUT, ZONE 1
H1/8	GREEN	(-) DOOR TRIGGER INPUT, ZONE 3
H1/9	BLACK/WHITE	(-) 200mA DOMELIGHT SUPERVISION OUTPUT
H1/10	WHITE/BLUE	(-) REMOTE START ACTIVATION INPUT
H1/11	WHITE	(+)/(-) SELECTABLE LIGHT FLASH OUTPUT
H1/12	ORANGE	(-) 500mA GROUND WHEN ARMED OUTPUT

➤ Auxiliary harness (H2), 6-pin connector

H2/1	LIGHT BLUE	(-) 200mA SECOND UNLOCK OUTPUT
H2/2	WHITE/BLACK	(-) 200mA AUX 3 OUTPUT
H2/3	VIOLET/BLACK	(-) 200mA AUX 2 OUTPUT
H2/4	GREEN/WHITE	(-) 200mA FACTORY ALARM REARM OUTPUT
H2/5	GRAY/BLACK	(-) WAIT-TO-START INPUT
H2/6	LIGHT GREEN/ BLACK	(-) 200mA FACTORY ALARM DISARM OUTPUT

➤ Door lock harness, 3-pin connector

1	LIGHT BLUE	(-) UNLOCK (+) LOCK OUTPUT
2	EMPTY	NOT USED
3	GREEN	(-) LOCK (+) UNLOCK OUTPUT

► Remote start ribbon harness, wiring diagram

1	PINK/WHITE	(-) 200mA PROGRAMMABLE IGN2/ACC2 RELAY TURN ON
2	YELLOW	(+) IGNITION INPUT TO ALARM
3	PINK	(-) 200mA IGNITION RELAY TURN ON
4	ORANGE	(-) 200mA ACCESSORY RELAY TURN ON
5	PURPLE	(-) 200mA STARTER RELAY TURN ON
6	ORANGE/BLACK	(-) ANTIGRIND/GROUND WHEN ARMED OUTPUT
7	BLUE	(-) 200 mA STATUS OUTPUT

The ribbon harness connects to the heavy gauge relay satellite.

► Heavy gauge relay satellite wiring diagram

H/1	PURPLE	STARTER OUTPUT TO STARTER (STARTER SIDE)
H/2	GREEN	STARTER INPUT FROM IGNITION (KEY SIDE)
H/3	RED	(+) (30A) HIGH CURRENT 12V INPUT
H/4	ORANGE	OUTPUT TO ACCESSORY CIRCUIT
H/5	PINK	OUTPUT TO PRIMARY IGNITION CIRCUIT
H/6	RED	(+) (30A) HIGH CURRENT 12V INPUT
H/7	PINK/WHITE	OUTPUT TO SECOND IGNITION CIRCUIT
H/8	RED/WHITE	(+) (30A) HIGH CURRENT 12V INPUT

► Relay satellite 4-pin connector

1	BLUE	(-) 200mA STATUS OUTPUT
2	ORANGE	(-) 200mA ACCESSORY RELAY TURN ON
3	PURPLE	(-) 200mA STARTER RELAY TURN ON
	PINK	(-) 200mA IGNITION RELAY TURN ON

➤ Remote start harness, (H3) 5-pin connector

H3/1	BLACK/WHITE	(-) NEUTRAL SAFETY SWITCH INPUT
H3/2	VIOLET/WHITE	TACHOMETER INPUT WIRE
H3/3	BROWN	(+) BRAKE SHUTDOWN INPUT WIRE
H3/4	GRAY	(-) HOOD PINSWITCH INPUT, ZONE 6
H3/5	BLUE/WHITE	(-) 200 mA 2ND STATUS/REAR DEFOGGER - Latched Pulsed

➤ AUX 4, Horn, (H4), 2-pin connector

H4/1	ORANGE/BLACK	(-) 200mA AUX 4 OUTPUT
H4/2	BROWN	(-) 200 mA HORN OUTPUT

Wire connection guides

➤ Primary harness (H1), 12-pin connector

H1/1	RED/WHITE	(-) 200mA AUX TRUNK RELEASE OUTPUT
------	-----------	------------------------------------

When the system receives the code controlling trunk release output for longer than 1.5 seconds, the red/white wire will supply output as long as the transmission continues. This is typically used to operate a trunk/hatch release or other relay-driven function.

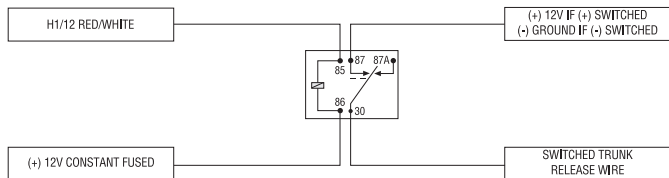



Warning! Never use this wire to drive anything but a relay or a low-current input, supplied output is only 200mA. Connecting directly to a solenoid, motor, or other high-current device will cause the module to fail.

H1/2

RED

(+)12v CONSTANT POWER INPUT

Before connecting this wire, remove the supplied fuse. Connect to the battery positive terminal or the constant 12V supply to the ignition switch.

Note: Always use a fuse within 12 inches of the point you obtain (+)12V. Do not use the 15A fuse in the harness for this purpose. This fuse protects the module.

H1/3

BROWN

(+) SIREN OUTPUT

Connect this to the red wire of the siren. Connect the black wire of the siren to (-) chassis ground, preferably at the same point you connected the control module's black ground wire. See Features Description section for horn output.

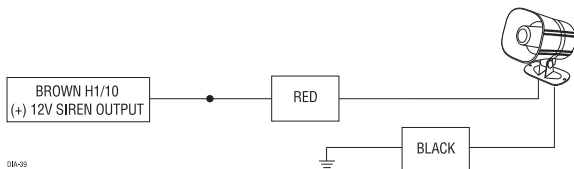

H1/5**BLACK****(-) CHASSIS GROUND**

We recommend that you do not use a factory ground. Ground all your components including the siren, to the same point in the vehicle, preferably the kick panel. Scrape away any paint and use a factory bolt, or make your own ground with a self-tapping screw and a star washer.

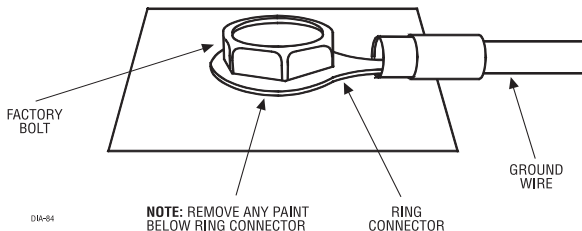

014-04

H1/6**VIOLET****(+) DOOR TRIGGER INPUT, ZONE 3**

This wire is used in vehicles that have a positive (+) switched dome light circuit. Connect the violet wire to a wire that shows (+) 12V when any door is opened, and ground when the door is closed. This wire reports Zone 3.

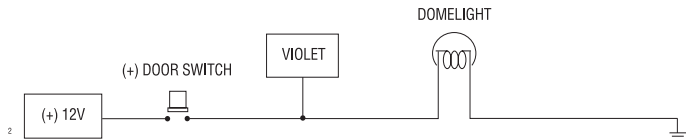

H1/7**BLUE****(-) INSTANT TRIGGER , ZONE 1**

This input responds to negative input with an instant trigger, it is ideal for a trunk pin. It can also be used with Directed single-stage sensors. This wire will report Zone 1.

H1/8**GREEN****(-) DOOR TRIGGER INPUT, ZONE 3**

Most vehicles use negative door trigger circuits. Connect the green wire to a wire which shows ground when any door is opened. In vehicles with factory delays on the dome light circuit, there is usually a wire that is unaffected by the delay circuitry. This wire reports Zone 3.

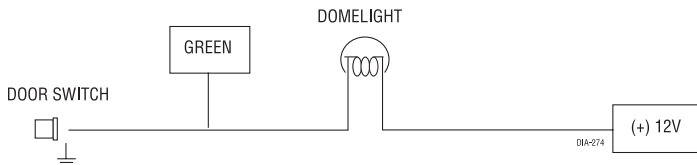

H1/9**BLACK/WHITE****(-) 200mA DOME LIGHT OUTPUT SUPERVISION OUTPUT**

Connect this wire to the optional dome light supervision relay as shown below: Important! This output is only intended to drive a relay. It cannot be connected directly to the dome light circuit, as the output cannot support the current draw of one or more light bulbs.

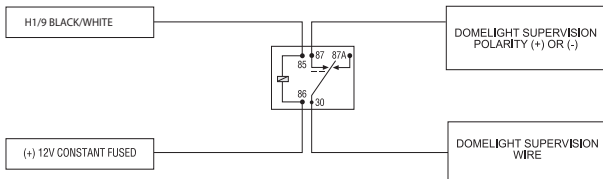
**H1/10****WHITE/BLUE****(-) REMOTE START ACTIVATION INPUT**

This input comes from the factory set to 1 activation pulse. This means that it is necessary to have a single pulse on the white/blue wire for the remote start to activate or to deactivate. The same holds true for the remote control activation it is necessary to press the  button once for the remote start to activate or deactivate.

Note: The number of activation inputs can be programmed to 1 or 2 pulses with an optional momentary switch. This setting affects both the input wire and the remote control when operating the remote starter.

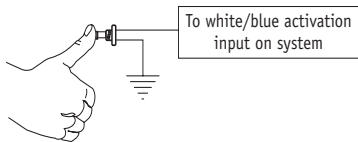

H1/11**WHITE****(+/-) SELECTABLE LIGHT FLASH OUTPUT**

This wire is connected to the (+) parking light wire in the vehicle. If the light flash polarity jumper on the side of the unit, is moved to the opposite position (See Programming Jumper section of this guide) this wire supplies a (-) 200 mA output.

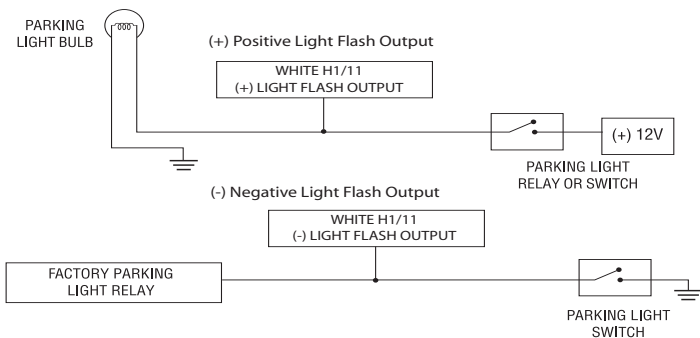

Note: For parking light circuits that draw 10-amps or more, the internal jumper must be switched to a (-) light flash output. (See Setting the light flash polarity section of this guide.) P/N 8617 or a standard automotive SPDT relay must be used on the H1/11 light flash output harness wire.

H1/12**ORANGE****(-) 500mA GROUND WHEN ARMED OUTPUT**

This wire supplies a (-)500 mA ground as long as the system is armed. The output ceases as soon as the system is disarmed. The orange wire may be wired to an optional Directed Electronics 8618 starter kill relay.

➤ Auxiliary harness (H2), 6-pin connector

H2/1	LIGHT BLUE	(-) 200mA 2nd UNLOCK OUTPUT
------	------------	-----------------------------

This wire produces a (-) 200mA output for progressive locks in which the driver door unlocks first and the remaining locks unlock with a second press of the unlock button.

H2/2	WHITE/BLACK	(-) 200mA PROGRAMMABLE AUX 3 OUTPUT
------	-------------	-------------------------------------

This wire provides 200 mA programmable output whenever the transmitter button(s) controlling AUX 3 is pressed. This output can be programmed to provide the following types of outputs

- Validity: Output that sends a signal as long as the transmission is received.
- Latched: Output that sends a signal when the AUX channel button is pressed and continues until the same button is pressed.
- Latched, reset with ignition: Similar to the latched output, this type of output turns On the first time the AUX channel button is pressed, and turns Off the next time the same button is pressed. This type of output additionally stops and resets whenever the ignition is turned On and then Off.
- 30 seconds (60, 90) timed: The output sends a continuous signal for 30 seconds.

Note: Bitwriter® programs from 1 to 90 seconds.

	<p>Warning! Never use this wire to drive anything but a relay or a low-current input, supplied output is only 200mA. Connecting directly to a solenoid, motor, or other high-current device will cause the module to fail.</p>
---	---

H2/3**VIOLET/BLACK****(-) 200mA PROGRAMMABLE AUX 2 OUTPUT**

This wire provides 200 mA programmable output whenever the transmitter buttons controlling AUX 2 is pressed.



Warning! Never use this wire to drive anything but a relay or a low-current input, supplied output is only 200mA. Connecting directly to a solenoid, motor, or other high-current device will cause the module to fail.

H2/4**GREEN/WHITE****(-) FACTORY ALARM REARM OUTPUT**

This wire sends a 200mA negative pulse every time the remote start shuts down or when the doors are locked. This can be used to pulse the arm wire of the vehicle's factory anti-theft device. Use a relay to send a (-) or (+) pulse to the arm wire.

H2/5**GRAY/BLACK****(-) DIESEL WAIT TO START BULB INPUT**

Connect this wire to the wire in the vehicle that sends the signal to turn on the WAIT-TO-START bulb in the dashboard. In most diesels the wire is negative (ground turns on the bulb) and the GRAY/BLACK wire can be directly connected to the wire in the vehicle. If the vehicle uses a positive wire (12V to turn on the bulb) a relay must be used to change the polarity.

Note: A 1-amp diode must be installed in line on the factory wire between the wait-to-start indicator and the ECM. (See the following diagrams for details).

(-) WAIT TO START WIRE

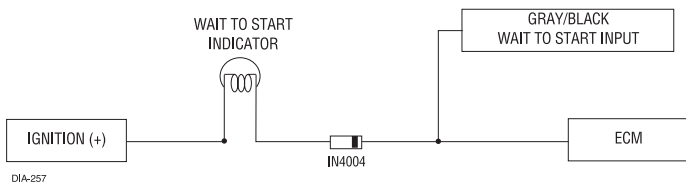

(+) WAIT-TO-START WIRE

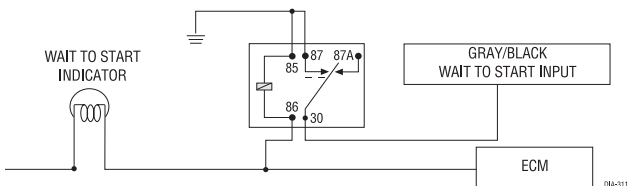

H2/6**LIGHT GREEN/BLACK****(-) 200mA FACTORY DISARM OUTPUT**

This wire sends a (-) 200mA pulse every time the remote start is activated, trunk release is activated (programmable on/off), or when the doors are unlocked with the remote. This can be used to pulse the disarm wire of the vehicle's factory anti-theft device. Use a relay to send a (-) or (+) pulse to the disarm wire as shown in the following diagrams.

Relay for Negative (-) Disarm Wire

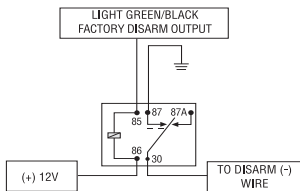

Relay for Positive (+) Disarm Wire

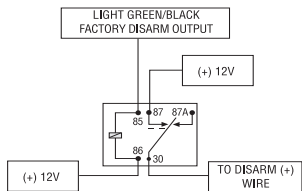

DEP108

► Heavy Gauge, relay satellite

The heavy gauge wires coming from the large pin connector are used to energize the high current circuits in the vehicle. It is crucial to ensure that these connections are capable of handling the current demands. For this reason, Scotch-Locks, T-taps and other such connectors are strongly discouraged.

H/1**PURPLE****(+) STARTER OUTPUT**

After cutting the starter wire connect the PURPLE wire to the end going to the starter motor.

H/2**GREEN****STARTER INPUT**

After cutting the starter wire connect the GREEN wire to the end going to the key side of the ignition.

H/3	RED (2)	(+) 12V INPUT FOR HIGH CURRENT OUTPUTS
------------	----------------	---

Remove the two 30-amp fuses prior to connecting these wires and do not replace them until the satellite has been plugged into the control module. These wires are the source of current for pink ignition, orange accessory, purple starter, and the coils for the relays in the relay pack. They must be connected to a high current source. Since the factory supplies (+)12V to the key switch that is used to operate the motor, it is recommended that these wires be connected there.

Note: If the factory supplies two separate (+) 12V feeds to the ignition switch, connect one RED wire of the satellite to each feed at the switch.

H/4	ORANGE	(+) ACCESSORY OUTPUT
------------	---------------	-----------------------------

Connect this wire to the accessory wire in the vehicle which powers the climate control system.

H/5	PINK	(+) IGNITION OUTPUT
------------	-------------	----------------------------

Connect this wire to the ignition wire in the vehicle.

H/6	PINK/WHITE	(+) SECOND IGNITION ACCESSORY OUTPUT
------------	-------------------	---

Connect this wire to the second ignition/accessory wire in the vehicle. (See menu feature 3-6.)

Note: For vehicles that do not have a second ignition/accessory wire, this connection is not required.

H/7	RED/WHITE	(+) 12V INPUT
------------	------------------	----------------------

Connect this wire to a +12V source. It supplies voltage to the pink/white 2nd ignition/accessory output. If the vehicle does not have a 2nd ignition/accessory, then this wire does not need to be connected.

► Relay satellite 4-pin connector

H/1	BLUE	(-) 200mA STATUS OUTPUT
------------	-------------	--------------------------------

This wire supplies a 200mA output when remote start process begins.

H/2	ORANGE	(-) 200mA ACCESSORY RELAY TURN ON
------------	---------------	--

The wire supplies a (-) 200mA output and controls two additional relays. Connect this wire to power additional accessory wires.

H/3	PURPLE	(-) 200mA STARTER RELAY TURN ON
------------	---------------	--

The wire supplies a (-) 200mA output and controls two additional relays. Connect this wire to power additional starter wires.

H/4	PINK	(-) 200mA IGNITION RELAY TURN ON
------------	-------------	---

The wire supplies a (-) 200mA output and controls two additional relays. Connect this wire to power additional ignition wires.

➤ Remote start, (H3) secondary harness

H3/1

BLACK/WHITE

(-) NEUTRAL SAFETY SWITCH INPUT

Connect this wire to the provided toggle (override) switch as shown in figure A. Connect the other wire from the toggle switch to the park/neutral switch in the vehicle. This wire will test with ground with the gear selector either in PARK or NEUTRAL. This will prevent the vehicle from accidentally being started while in a drive gear. This input **MUST** rest at ground in order for the remote start system to operate. Connected properly the vehicle will only start while in PARK or NEUTRAL.

In some vehicles, the park/neutral position switch activates a factory starter lock out that will not allow the starter to operate in a drive gear. In these vehicles, connect this wire to the toggle switch as shown in figure B. Connect the other wire from the toggle switch to chassis ground.

Important: Always perform the Safety Check section of this installation guide to verify that the vehicle cannot be started in ANY drive gear and that the override switch is functioning properly.

Figure A

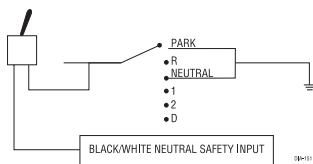
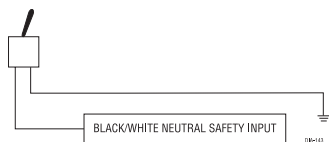

Figure B



H3/2**VIOLET/WHITE****TACHOMETER INPUT**

This input provides the module with information about the engine's revolutions per minute (RPMs). It can be connected to the negative side of the coil in vehicles with conventional coils. In multi-coil and high energy ignition systems locating a proper signal may be more difficult. Once connected, you must teach the system the tach signal. (See the Internal Programming Jumpers section of this guide.)

H3/3**BROWN****(+) BRAKE SWITCH INPUT, ZONE 1**

This wire **MUST** be connected to the vehicle's brake light wire. This is the wire that shows (+) 12V when the brake pedal is depressed. The remote start will be disabled or shut down any time the brake pedal is depressed.

H3/4**GRAY****(-) HOOD PIN SWITCH INPUT, ZONE 6**

This wire **MUST** be connected to a hoodpin switch. This input will disable or shut down the remote start when the hood is opened. It will also trigger the security system if the hood is opened while the system is armed and report Zone 6.

H3/5**BLUE/WHITE****(-) 200mA STATUS OUTPUT**

This wire supplies a 200mA output as soon as the module begins the remote start process. The H3/1 Blue/White wire can also be used to activate the defogger trigger (latched/pulsed), 10-seconds after the remote start engages. (See the Feature Descriptions section in this guide for details about programming this output.)

➤ AUX 4, Horn, (H4) 2-pin connector

H4/1

ORANGE/BLACK

(-) 200 mA PROGRAMMABLE AUX 4 OUTPUT

This wire provides a (-) 200mA output whenever the transmitter button(s) controlling AUX 4 is pressed. (see also the Feature Descriptions section and previous AUX 3 description)



Warning! Never use this wire to drive anything but a relay or a low-current input, supplied output is only 200mA. Connecting directly to a solenoid, motor, or other high-current device will cause the module to fail.

H4/2

BROWN

(-) 200mA HORN OUTPUT

This wire is a low current output (200mA) and can be hooked to the horn honk wire in the vehicle. It can be programmed to sound only during full trigger, or to be used as a siren output with arm/disarm chirps. Refer to System Features Menu #1, Feature 13 for more information.



Warning! Never use this wire to drive anything but a relay or a low-current input, supplied output is only 200mA. Connecting directly to a solenoid, motor, or other high-current device will cause the module to fail.

Neutral safety switch interface

Some vehicles do not have an electrical neutral safety switch. Instead, the vehicle has a mechanical neutral safety switch that physically interrupts the starter wire and is used when the vehicle is in any drive gear. If the remote start is interfaced before this switch, it will provide protection from starting in gear. However, some vehicles combine the column shift mechanism and the mechanical neutral safety switch into one mechanical part.

Note: You must complete the remote start system installation before doing the following test. Ensure that the remote start system is functioning normally. This includes connecting to the brake as a shut-down.

► Testing the neutral safety switch

1. Make sure there is adequate clearance to the front and rear of the vehicle because it may move slightly.
2. Make sure the hood is closed and there are no remote start shut-downs active.
3. Set the emergency brake.
4. Turn the key to the "run" position, this will release the shifter.
5. Place the car in drive (D).
6. Place your foot directly over the brake pedal, but do not depress it. Be ready to step on the brake if the starter engages.
7. Activate the remote start system.
8. If the starter engages, immediately depress the brake to shut the remote start system down. If the starter does not engage, no additional safety system is required.

If the starter engages and the vehicle is a General Motors product or Dodge Dakota pickup, you can find an alternative shut-down method to prevent the starter from engaging. Refer to www.directechs.com for Document 1008 under the Resource tab. If the vehicle is not a General Motors product or a Dodge Dakota pickup, please call Directed Electronics Technical Support for an alternative shut-down method.

Do not return the vehicle to the customer until this feature is properly installed!

Plug-in LED and valet/program switch

These plug into the module. The Status LED plugs into the white two-pin socket, while the Valet /Program Switch should be plugged into the blue two-pin socket. The Status LED and Valet switch fits into a 9/32-inch hole.

Status LED

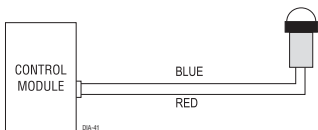

Valet/Program Switch

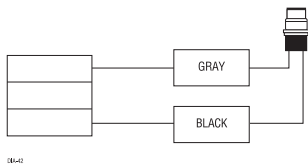

D2D programmer interface - 4-pin red plug

The 4-pin red port is for interfacing with an Xpresskit module through D2D, or you can use it for programming with the Bitwriter®. If the Xpresskit module is unplugged so the port can be used for Bitwriter programming, you must power down the remote start system by unplugging the 12-pin harness before reconnecting the the Xpresskit module. Once the Xpresskit module has been plugged in, reconnect the remote start 12-pin harness and proceed to reprogram the Xpresskit module. For more information go to www.xpresskit.com

Shock sensor harness, 4-pin connector

H	GREEN	(-) MULTIPLEX INPUT, ZONE 4
----------	--------------	------------------------------------

Inputs shorter than 0.8 seconds will trigger the Warn Away® response, while inputs longer than 0.8 seconds will trigger full alarm sequence and report Zone 4. If installing an optional Directed Electronics dual stage sensor, connect to the green wire as shown below.

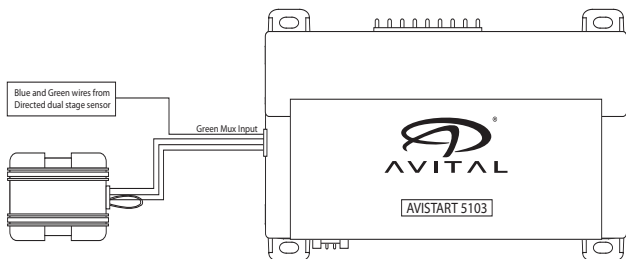

H	BLUE	(-) MULTIPLEX INPUT, ZONE 2
----------	-------------	------------------------------------

Inputs shorter than 0.8 seconds will trigger the Warn Away® response, while inputs longer than 0.8 seconds will trigger full alarm sequence and will also report Zone Two.

H	RED	(+) 12V CONSTANT
----------	------------	-------------------------

Do not use for anything besides the plug-in shock sensor.

H	BLACK	(-) GROUND
----------	--------------	-------------------

Do not use for anything besides the plug-in shock sensor

Tachometer settings

► Virtual tach

To program Virtual Tach:

1. After the install is complete, remote start the car.
2. If the car does not start on the first attempt, let the remote start attempt again.
3. Once the car starts, let it run until the parking lights come on.
4. When the parking lights come on, shut off the remote start with the remote - that's it! Virtual Tach is programmed.

To reset Virtual Tach, go into the remote programming grid and choose option #4. Virtual Tach **cannot** be reset with the Bitwriter.

Virtual Tach handles disengaging the starter motor during remote starting – it does not address over-rev. If the customer wants to have the over-rev protection capability, the tach wire must be connected. This may involve more installation shop charges than initially quoted.

Important: If the Virtual Tach mode over cranks or doesn't crank the vehicle long enough to start and run the car, use the Bitwriter to add or subtract the starter output time. You can adjust the output time in increments of 50mSec of the learned time using the Bitwriter.

► Tach learning

To learn the tach signal:



1. Start the vehicle with the key.



2. Within 5 seconds, press and hold the Valet/Program switch.



3. After 3 seconds the LED will light constant when the tach signal is learned.



4. Release the Valet/Program switch.

Programming jumpers

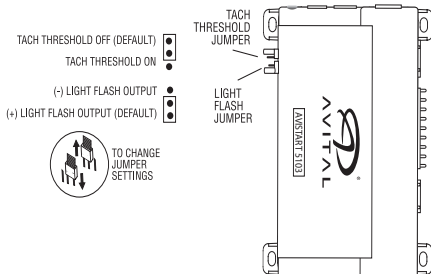

► Tach threshold On/Off

In most cases, this jumper can be left in the Off position. Some new vehicles use less than 12 volts in their ignition systems. The unit may have trouble learning the tach signal in these vehicles. Changing the jumper to the On setting changes the trigger threshold of the digital tach circuit so that it will work with these type vehicles.

► Light flash (+) / (-) polarity

This jumper is used to determine the light flash output. In the (+) position, the onboard relay is enabled and the unit outputs (+)12V on the white H1/11 wire. In the (-) position, the onboard relay is disabled and the white H1/11 supplies a 200mA (-) output, suitable for driving factory parking light relays.

Note: For parking light circuits that draw 10 amps or more, the internal jumper must be switched to a (-) light flash output. P/N 8617 or a standard automotive SPDT relay must be used on the H1/11 light flash output harness wire.

Transmitter/receiver Learn Routine™

The system comes with transmitters that have been taught to the receiver. The receiver can store up to 4 different transmitter codes in memory.



If the learn routines have been programmed previously using the Bitwriter, the routines may be locked. Before proceeding with reprogramming the learn routines, they must be unlocked with the Bitwriter. This cannot be done manually with the Valet switch.

Bitwriters require software v2.6 Bitwriters with date code of 6A or older require an IC upgrade (p/n 998M). Some Bitwriters with a date code of 6B do not require the IC upgrade, refer to Tech Tip # 1112 for more information.

Use the following learn routine to add transmitters to the system:

The Valet/Program switch, plugged into the blue port, is used for programming. There is a basic sequence to remember whenever programming this unit: Door, Key, Choose, Transmit and Release.



1. Open a door. (The GREEN wire, h1/8, or the VIOLET, H1/6 must be connected.)



2. Insert the key. Turn the ignition to the ON position. The heavy gauge pink wire must be connected.



3. Choose. Within 10 seconds, press and release the Program switch corresponding to the number of the desired function step listed in the following table.

Once you have selected the function step, press the switch once more and hold it. The LED flashes and the siren chirps to confirm the selected functional step. Do not release the Program switch.

Step	Function
1	Auto Learn Standard Configuration (default) The auto learn configuration automatically sets up the remote button configuration.
2	Delete remotes: This feature erases all remotes from the system memory. This is useful in cases when a customer's remote is lost or stolen. Note: Does not reset the programmed features of the system or reset the Virtual Tach setting.
3	Reset Features: This resets all the features of the system to the factory default settings. Note: Does not delete the remotes from the system or reset the Virtual Tach setting.
4	Virtual Tach Reset: Deletes all previously learned values for Virtual Tach, and on the next remote start sequence the unit begins virtual tach initialization. Note: The "Zap" feature on the Bitwriter does not reset the Virtual tach setting.



4. Transmit. While holding the Valet/Program switch, press the  button on the remote control. The siren chirps to confirm that the code has been successfully programmed. It is not possible to teach a remote control button to the system more than once.



DIRM-34

5. Release. Once the code is learned, the Valet/Program switch can be released.

You can advance from programming one channel to another by releasing the Valet/Program switch and tapping it to advance channels and then holding it.

If you want to program Step 3 after programming Step 1, release the Valet/Program switch, press it twice and release it to advance to Step 3. Then press it once more and hold it. The siren chirps three times and the LED flashes three times to confirm it is ready to receive the code from the transmitter.

















Learn Routine is exited if:

- Door is closed.
- The ignition is turned off
- The program switch is pressed too many times
- More than 15 seconds elapses between steps

Transmitter configurations

The transmitters are programmed with the standard configuration by using the Auto Learn functions in the Transmitter/Receiver Learn Routine. For more information about the remote control functions, see the Owners Guide.

► Standard configuration

		operates	Arm / Lock Panic ON/ Panic OFF
		operates	Disarm/Unlock Panic OFF
		operates	Remote Start
		operates	AUX Trunk Release
 and 		operates	Timer Mode
 and 		operates	Short Run/Turbo timer
 and 		operates	AUX 2
 and 		operates	AUX 3
 and  and 		operates	Rear Defogger
 and 		operates	AUX 4

Multi-level security arming

Multi-Level Security Arming is a feature that allows the user to select which system inputs or sensors will be active, or will be bypassed when the system is armed. (See Table of Zones section of this guide.)

Pressing the arm button again within five seconds of arming the system activates the Multi-Level Security feature. Each time the arm button is pressed after arming, a different security level is selected. The different levels of security are selected as follows:

Pressing  one time: The siren chirps once. The system is armed.

Pressing  a second time within five seconds: The siren chirps twice followed by a long chirp. Zone Two is now bypassed.

Pressing  a third time within five seconds: The siren chirps three times followed by a long chirp. Zone Four is now bypassed.

Pressing  a fourth time within five seconds: The siren chirps four times followed by a long chirp. Zones Two and Four are now bypassed.

Pressing  a fifth time within five seconds: The siren chirps five times followed by a long chirp. All input zones, except the ignition, are now bypassed.

System features learn routine

The System Features Learn Routine dictates how the unit operates. It is possible to access and change any of the feature settings using the Valet/program switch, however this process can be simplified using the Bitwriter®.

Any of the settings can be changed and then assigned to one of four remote controls. This feature is called Owner Recognition. Each time a particular remote control is used to disarm the system, the assigned feature settings are recalled. Owner Recognition is only possible when programming the unit via the Bitwriter®.



If programming with the Bitwriter®, the learn routine can be locked or unlocked. If the learn routine has been locked using the Bitwriter, it must be unlocked with Bitwriter® - this cannot be done manually with the Valet switch.





1. Open a door. (The GREEN wire, H1/8 or the VIOLET, H1/6 must be connected).
2. Ignition. Turn the ignition On, and then Off.
3. Select a Menu. Press and hold the Valet Program switch. When the LED flashes once and the siren chirps, Menu One is selected. Continue to hold the switch until the LED flashes twice and the siren chirps twice, Menu Two is selected. Release the switch after the menu choice has been selected.



4. Choose. Within 10 seconds, press and release the Valet/Program switch the number of times corresponding to the feature number you want to program, and then press and hold the switch.

(See Feature Menus.) After a second the LED flashes and the siren chirps to indicate which feature is accessed. For example, in Menu Three, a group of five flashes indicates access to the activation pulse setting (Feature 3-5). The siren also chirps eight times.



5. Transmit. The transmitter is used to select the desired setting. Pressing  changes the feature to the one chirp setting. Pressing  changes the setting to the 2 chirp setting (or chirps two or more times for features with more than 2 settings) .



6. Release, the Valet/program switch.

You can advance between features by pressing and releasing the Valet/Program switch the number of times it takes to move from the feature you just programmed to the feature you want.

For example: If you just programmed Feature 1-2 in Menu One, and you then want to program Feature 1-3 to Off, press and release the program switch once to advance from Feature 1-2 to Feature 1-3. Then press it once more and hold it. The LED flashes in groups of 3, and the siren chirps to confirm that you have accessed Feature 1-3.

The learn routine is exited when:

- The door is closed.
- The ignition is turned on.
- The Valet/Program switch is pressed too many times.
- More than 15 seconds elapses between programming steps.

One long siren chirp indicates that the Learn Routine has been exited.

Feature menus

The default settings are indicated in bold type. Features that have additional settings that can be programmed using the Bitwriter® are indicated with an asterisk (*) The number in parenthesis indicates the number of times the LED flashes and the horn honks.

► Menu 1 - Basic

Menu Item	One-chirp setting	Two-chirp setting
1	Active Arming	Passive arming
2	Arm/disarm chirps on	Arm/disarm chirps Off
3	Ignition lock On	Ignition lock Off
4	Ignition unlock On	Ignition unlock Off
5	Active locking only	Passive locking
6	Panic with ignition On	No panic with ignition On
7	0.8 second door lock pulses (1)	3.5 (2), 0.4 (3) seconds
8	Forced passive arming on	Forced passive arming off
9	Automatic engine disable on	Automatic engine disable off
10	Armed When Driving (AWD) on	AWD Off
11	Code Hopping On	Code Hopping off
12	Horn Output Pulsed	Constant
13	Horn function Full Alarm Only (1)	Siren function - chirp length 20mS (2), 30mS (3), 40mS (4), 50mS (5)
14	Comfort Closure ON	Comfort Closure OFF (2), Comfort Closure 2 (3)

► Menu 2 - Advanced

Menu Item	One-chirp setting	Two-chirp setting
1	30 second siren duration	60 second siren duration*
2	Nuisance Prevention Circuitry On	Nuisance Prevention Circuitry OFF
3	Progressive door trigger	Instant door trigger
4	Disarm from Valet, 1 pulse	Disarm from Valet, 2-5 pulses
5	Door trigger error chirp On	Door trigger error chirp OFF
6	Ignition controlled domelight On	Ignition controlled domelight OFF
7	Unlock output 1 pulse	Unlock output 2 pulses
8	Lock output 1 pulse	Lock output 2 pulses
9	Factory disarm with trunk release On	Factory disarm with trunk release Off
10	FAD function with Unlock (1)	Before Unlock (2), Remote Start only (3)
11	FAD 1 pulse	2 pulses
12	AUX 2 validity (1)	Latched(2), Latch reset with ignition (3)30-secs timed (4), 60-secs (5), 90-secs (6)
13	AUX 2 Linking None (1)	Arm (2)/Disarm (3), Remote Start (4)
14	AUX 3 validity (1)	Latched (2), Latch reset with ignition (3), 30-sec. timed (4)
15	AUX 2 linking None (1)	Arm (2)/Disarm (3), Remote Start (4)
16	AUX 4 validity (1)	Latched (2), Latch reset with ignition (3), 30-sec. timed (4)
17	AUX 4 linking None (1)	Arm (2)/Disarm (3), Remote Start (4)

*Bitwiter® can set 1 - 180 seconds

► Menu 3 - Remote start

Menu Item	One-chirp setting	Two-chirp setting
1	Engine checking: Virtual Tach	Voltage(2), OFF(3), Tachometer(4)
2	Remote start runtime: 12 mins	24 min, 60 min
3	Parking light output: Constant	Flashing
4	Cranking time: 0.6 sec	0.8, 1.0, 1.2, 1.4, 1.6, 1.8, 2.0, 4.0 second
5	Activation pulse 1	2
6	2nd Ignition/Acc output: Ignition	Accessory
7	Acc state during wait-to-start Off	On
8	2nd status output: Normal	Rear defogger: latch 10 min. rear defogger pulse
9	Anti grind: On	Off
10	Diesel timer: Wait-to-Start input	Timed 15 , 30 ,45 seconds*
11	Timer mode run time: 12 min	3, 6, 9, min
12	Timer mode: Timed starts	Temp starts
13	Short run (turbo): 1 min	3,5, 10 min

*Bitwriter® can set 1 - 180 seconds.

Feature descriptions

The features of the system are described below. Features that have additional settings when programming with the Bitwriter® are indicated by the following icon: 

Default settings are in bold. The numbers in parentheses indicate the number of times the Status LED flashes.

► Menu 1 - Basic

1-1 Active/Passive Arming: When active arming, the system arms only when the transmitter is used. When set to passive, the system arms automatically 30 seconds after the last door is closed. To alert the consumer of passive arming, the siren chirps 20 seconds after the door is closed. This provides the consumer with an audible warning prior to the system actually arming. At the 30 second mark, the system arms, but the siren does not chirp.

1-2 Chirps On/Off: This feature controls the chirps that confirm the arming and disarming of the system.

1-3 Ignition Lock On/Off: When turned On, the doors lock 3 seconds after the ignition is turned On.

1-4 Ignition unlock On/Off: When ON this feature unlocks the doors when the ignition is turned Off

1-5 Active/Passive Locking: If passive arming is selected in Feature 1-1, then the system can be programmed to either lock the doors when passive arming occurs, or only lock the doors when the system is armed via the transmitter. Active locking means the system will not lock the doors when it passively arms. Passive locking means that the system will lock the doors when it passively arms.

Note: Remember, when passive arming is selected, the unit will chirp 20 seconds after the last door is closed. The system does not actually arm or lock the doors until 30 seconds after the door has been closed.

1-6 PANIC WITH IGNITION ON: This feature controls whether or not the panic mode is available with the ignition on. In some states, there are laws prohibiting a siren sounding in a moving vehicle. This feature makes the system compliant with these regulations.

1-7 DOOR LOCK PULSE DURATION: The default setting is **0.8** second door lock pulses. Some European vehicles, such as Mercedes-Benz and Audi require longer lock and unlock pulses to operate the vacuum pump. Programming the system to provide 3.5 second (2) pulses, accommodates the door lock interface in these vehicles. (Refer to Tech Tip 1041 on www.directechs.com, for wiring information regarding Type E door locks interfacing). The 0.4 second (3) pulse is required on some vehicles where the lock wires also control the windows. The 0.8 second pulse causes the windows to open/close when locking or unlocking.

1-8 FORCED PASSIVE ARMING ON/OFF: To use this feature, passive arming must be selected in Feature 1-1. When turned on, forced passive arming will ensure that the system will passively arm, even if a zone is left open or invalid. Forced passive arming occurs one hour after the ignition is turned off.

1-9 AUTOMATIC ENGINE DISABLE (AED) ON/OFF: AED is a full-time, passive starter disable that works independently of the security system. When turned on, the orange, ground-when-armed output (H1/12) will activate 30 seconds after the ignition is turned off. The LED will flash at half its normal rate when the ignition is turned off to indicate that AED is active and will interrupt the starter in 30 seconds. AED does not occur in Valet mode and can be bypassed using the emergency override procedure. The transmitter can be used to disarm AED, however, the system must be armed and then disarmed, using the transmitter, to disarm AED.

1-10 ARMED WHILE DRIVING (AWD) ON/OFF: In the default setting (Armed While Driving), the system can be armed with the ignition on. When armed, the ground-when-armed is not active and the sensors are bypassed. The door triggers will remain active.

1-11 CODE HOPPING® ON/OFF: The system uses a mathematical formula to change its code each time the transmitter and receiver communicate. This makes the group of bits or "word" from the transmitter very long. The longer the word is, the easier it is to block its transmission to the unit. Disabling the Code Hopping® feature lets the receiver ignore the Code Hopping® part of the transmitted word. As a result, the unit may have better range with Code Hopping® off.

1-12 HORN OUTPUT PULSED/CONSTANT: Program for either a pulsed output or a continuous output when the system is triggered.

1-13 HORN FUNCTION FULL ALARM ONLY(1)/SIREN FUNCTION (20mS (2), 30mS (3), 40mS (4), 50mS (5): The horn output factory setting is programmed for sound when the alarm is triggered. When programmed for siren function the horn output triggers as the siren. (arming/disarming, WarnAway, and full trigger with timing options).

1-14 COMFORT CLOSURE—ON (1), OFF (2) Comfort Closure 2 (3): The system can be programmed to close the windows when the system is locked. If programmed On, the lock output provides a 20 second pulse when the system is locked. The output is cancelled if the unlock button is pressed. In the Off setting the alarm does not perform this function.

(2) Comfort closure 1 - Activates the 20 second timer after the door lock pulse.

(3) Comfort closure 2 - Activates the 20 second timer with the door lock pulse.

To test if the car has the comfort closure:

1. Insert the key into the drivers door key cylinder.

2. Turn the key to the lock position and hold for about 10 seconds. Some cars require that you turn the key once, release, and then turn and hold into the lock position.

If Comfort closure is available, the windows (and in some cars the sunroof) close.

Important: Comfort closure can only be used on cars that have the capability of closing the windows (and on some cars the sunroof as well) with the key cylinder in the door.

► Menu 2 - Advanced



2-1 SIREN DURATION 30/60 SECONDS: It is possible to program the unit to sound for 30 or 60 seconds during the triggered sequence. Some states have laws regulating how long a security system can sound. When using the Bitwriter®, the siren can be programmed to sound for any length of time from 1 second to 180 seconds.

2-2 NUISANCE PREVENTION® CIRCUITRY (NPC) ON/OFF: NPC stops repeated triggering of the same zone. If one zone is triggered three times in one hour, that zone is bypassed for one hour, starting from the time of the third trigger. During that hour, if the system sees a trigger on that zone again, the system resets the one hour timer. If one hour passes and the zone has not triggered again, the zone is activated and can trigger the system again. NPC only monitors sensor inputs, and does not bypass the door trigger or the ignition trigger at any time. If NPC is turned off, the system will respond to repeated triggers on the sensor inputs and will do so indefinitely. Some states have laws regulating how many times a security system can trigger before it is considered a nuisance and the vehicle is towed away.

2-3 PROGRESSIVE DOOR TRIGGER ON/OFF: The system responds to a door trigger input with a progressive response. When the door is opened with the system armed, the siren will chirp 10 times prior to the full triggered sequence. The door trigger is still treated as an instant trigger and closing the door quickly will not prevent full triggered sequence from occurring. If the progressive door trigger is programmed off, the full siren output will occur the moment the door is opened.

2-4 VALET DISARM PULSE COUNT 1 TO 5 PULSES: The system can be programmed to count the number of presses of the valet switch before disarming the security system. The factory default setting is one pulse. The unit can also be set for two to five pulses.

Ghost Switch option: For added security, the GRAY wire on the two-pin Valet/Program plug can be connected to any switch in the vehicle that provides a positive (+) momentary pulse.

2-5 DOOR TRIGGER ERROR ON/OFF: This feature controls the error chirp that is generated if the system is armed with the door trigger active. This is useful in vehicles that have a long dome light delay after the door has been closed. If the system is armed before the dome light has turned off, the security system will generate the door trigger error chirp. If this error chirp is not desired, use this feature to disable the door open error chirp. If the bypass chirp is turned off, no bypass chirp will be generated, even if a door is accidentally left open.

2-6 IGNITION CONTROLLED DOME LIGHT SUPERVISION ON/OFF: If turned on, the system will turn on the dome light for 30 seconds when the ignition is turned off. The optional dome light supervision feature must be installed as described in the Wire Connection Guide.

2-7 UNLOCK OUTPUT—1, 2 PULSES: This will program the unlock output to one or two pulses. When the double pulse unlock feature is turned on, the BLUE door lock harness wire will supply two negative pulses instead of a single pulse. At the same time, the GREEN door lock harness wire will supply two positive pulses instead of a single pulse. This makes it possible to directly interface with double pulse vehicles without any extra parts for unlock and lock outputs (see below).

2-8 LOCK OUTPUT—1, 2 PULSES: This will program the lock output to one or two pulses. When the double pulse lock feature is turned on, the BLUE door lock harness wire will supply two positive pulses instead of a single pulse. At the same time, the GREEN door lock harness wire will supply two negative pulses instead of a single pulse.

2-9 FACTORY ALARM DISARM WITH TRUNK RELEASE: ON/Off. In the default setting the factory alarm disarm output, disarms the factory alarm anytime the trunk release control button is pressed. When programmed OFF, the factory alarm disarm does NOT output a pulse when the button controlling the trunk release is pressed.

2-10 FACTORY ALARM DISARM—WITH UNLOCK (1), BEFORE UNLOCK (2), REMOTE START ONLY (3): In the default setting the factory alarm disarm output disarms the factory alarm anytime the Unlock button is pressed. The BEFORE UNLOCK output disarms the factory alarm before the unlock output activates and before remote start is activated. The REMOTE START ONLY output disarms the factory alarm only before the remote start is activated.

2-11 **FACTORY ALARM DISARM PULSES—SINGLE, DOUBLE**: Selectable for a single or double-pulse for the vehicle's factory alarm disarm requirements.

2-12 **AUX 2 VALIDITY(1)/LATCHED (2)/LATCHED RESET WITH IGNITION(3) /30(4), 60(5) and 90(6) SEC TIMED OUTPUT**: This wire provides a (-) 200mA output whenever the transmitter buttons controlling AUX 2 are pressed. This output can be programmed to provide the following outputs (see also the Feature Menu section):

- Validity: Output sends a signal as long as the transmission is received.
- Latched: Output sends a signal when the AUX 1 button is pressed, and will continue until the same combination of buttons are pressed again.
- Latched, reset with ignition: Similar to the latched output, this output turns on the first time the AUX 1 button is pressed, and turns off the next time the same combination of buttons are pressed. Additionally the output stops and resets whenever the ignition is turned On and then Off.
- 30-second timed: Output sends a continuous signal for 30 seconds.



Note: All AUXiliary channel timed outputs can be programmed using the Bitwriter (1-90 seconds).

2-13 **AUX 2 LINKING NONE (1)/ARM (2), DISARM (3), REMOTE START(4)**: When programming to validity or timed output this can be programmed to activate when arming or disarming (or remote starting) with the transmitter.

2-14 **AUX 3 VALIDITY(1)/LATCHED(2)/LATCH RESET WITH IGNITION (3)/30(4), 60, 90 SEC TIMED OUTPUT**: AUX 3 can be programmed for these output configurations. The unit is set to the default validity output. To change the configuration, use the two-chirp setting to toggle through the different configurations. Refer to feature 2-10 for additional detail.

2-15 **AUX 3 LINKING NONE (1)/ARM(2), DISARM(3), REMOTE START(4)**: Refer to feature 2-13 for additional detail.

2-16 **AUX 4 VALIDITY (1)/LATCHED(2)/LATCHED RESET WITH IGNITION(3)/30(4), 60, 90 SEC TIMED OUTPUT:** AUX 3 can be programmed for these output configurations. The unit is set to the default validity output. To change the configuration, use the two-chirp setting to toggle through the different configurations. Refer to feature 2-10 for additional detail.

2-17 **AUX 4 LINKING NONE (1)/ARM (2), DISARM(3), REMOTE START (4):** Refer to feature 2-13 for additional detail.

► Menu 3 - Remote start

3-1 Engine Checking Virtual Tach: Voltage/ Off/Tach (1) When set to virtual tach the remote start monitors the cranking voltage of the vehicle and sets it as a reference point. Fifteen seconds after the crank output sequence the remote start checks the voltage again to determine if the vehicle is running.

When set to voltage (2), the unit cranks the starter for the programmed time and then attempts to sense that the engine is running by detecting an increase in voltage.

If programmed Off (3), the vehicle cranks for the programmed crank time. The tach setting or voltage setting is not checked to verify that the car is running. In the OFF setting, if the vehicle fails to start, the ignition stays on for the run duration. Using tach or either of the voltage settings is recommended.

When set to Tachometer, (4) the unit references the learned tach signal to disengage the starter. In addition it will monitor the RPM and shut down if the engine RPM is too high or too low.

3-2 RUN TIME 12, 24, 60 MINUTES:  Selects the time in minutes that the system will operate the engine until the system "times out". This is the maximum operation period and the system may be shut down using a shutdown at any time. Using the Bitwriter®, the run time can be programmed for any duration from 1-60 minutes.

3-3 Parking Lights Constant: In the default setting, the parking lights (if connected) comes on solid during the remote start runtime. In the two- flash setting

the parking lights will flash during the remote start runtime. In the OFF setting, the parking lights will not come ON or flash, when the vehicle is remote started.

3-4 CRANK TIME 0.6/0.8/1.0/1.2/1.4/1.6/1.8/2.0/4.0 SECONDS: If the unit is programmed for no engine checking or voltage sense, the crank time must be set to the appropriate duration. The default setting is 0.6 second. If a different crank time is desired, you can toggle through the higher settings by using the two-chirp settings.

3-5 ACTIVATION PULSE 1: This allows the system to use 1 or 2 pulses to activate the remote start sequence. The default setting is 1-pulse.

Note: This setting affects both the White/Blue input wire and the remote control.

3-6 2nd IGNITION/ACCESSORY OUTPUT: This will allow the PINK/WHITE to be used as a 2nd ignition or an accessory. The default is 2nd ignition.

3-7 ACCESSORY STATE DURING WAIT-TO-START OFF/ON: This feature will allow the selection of the accessory output to be ON or OFF during wait-to-start time period.

3-8 2nd STATUS OUTPUT NORMAL/REAR DEFOGGER LATCHED 10-MIN/PULSE: This feature will allow selection of status output or a rear defogger mode that turns on ten seconds after the vehicle has started if the vehicle interior temperature is below 55 degrees F. The defogger mode has two selections, latched or pulsed. Latched mode will only stay on for 10 minutes.

3-9 ANTI-GRIND ON/OFF: With the anti-grind On (default) the ground-when-armed output will be active during remote start operation. If accessories such as a voice module or window module are added to the unit, it may be necessary to program this feature off.

3-10 DIESEL TIMER—WAIT-TO-START/15, 30, 45 SECONDS:  Default is the H2/5 Gray/Black "Wait-to-Start" input control wire. This system has an onboard timer so the "wait-to-start" control wire does not need to be connected. The timer can be programmed to a 15, 30 or 45 second delay. This feature can also be programmed using the Bitwriter® with a delay from 1 to 90 seconds.

3-11 **TIMER MODE RUN TIME—12, 3, 6, 9 MINUTES:**  Selects the time in minutes that the system will operate the engine when timer mode activates the remote start. During the runtime the remote start can be shut down with any of the shutdown inputs. Using the Bitwriter the run time can be programmed for any duration from 1-16 minutes.

3-12 **TIMER MODE—TIMED STARTS/TEMPERATURE STARTS:** The system will start every 3-hours (a maximum of 6 times) until canceled by the brake, hood, or neutral safety shut-down wires, or when the ignition is turned on. The temperature start mode will not start the vehicle unless the interior temperature of the vehicle is less than 0 degrees F. The temperature start mode will exit after 18 hours.

3-13 **SHORT RUN/TURBO 1/3/5/10 MINUTES:** When the  and **AUX** buttons are pressed simultaneously the vehicle engine runs for a pre-programmed runtime to conveniently cool down the turbo after you have left the vehicle. The factory default is 1 minute.

NPC, Valet Mode, Rear defogger, Timer Mode

For information on Nuisance Prevention Circuitry (NPC), Valet Mode, Rear Defogger control and Timer Mode, refer to the Owner's Guide at www.directed.com.

Table of zones

When using the Diagnostic functions, use the Table of Zones to see which input has triggered the system. It is also helpful in deciding which input to use when connecting optional sensors and switches.

Zone No.	Trigger Type	Input Description
1	Trunk Input	BLUE (H1/7)
2	Multiplexed Shock Sensor Input	Mux BLUE sensor port wire
3	Door Trigger	GREEN (H1/8) and VIOLET (H1/6).
4	Multiplexed Optional Sensor Input	Mux GREEN sensor port wire
5	Ignition	Yellow ribbon harness wire
6	Hood Trigger	GRAY on the 6-pin shutdown harness

Long term event history

The system stores the last two full triggers in memory. These are not erasable. Each time the unit sees a full trigger, the older of the two triggers in memory will be replaced by the new trigger. To access long term event history:



1. With the ignition off, press and hold the Valet/Program switch.



2. Turn on the ignition.



3. Release the Valet/Program switch.

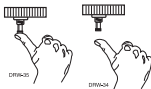

4. Press and release the Valet/Program switch within 5 seconds. The LED will flash in groups indicating the last two zones that triggered the unit. The LED will flash for one minute or until the ignition is turned off.

NOTE: The Warning Zone triggers are not stored to memory and will not be reported.

Shutdown diagnostics

To perform shutdown diagnostics:

1. With the ignition OFF, press and hold the Valet/Program switch.
2. Turn the ignition ON and then back OFF while holding the Valet/Program switch.
3. Release the Valet/Program switch.
4. Press and release the Valet/Program switch. The LED flashes to report the last shutdown for one minute or until the ignition is turned on, as shown in the following table:

LED Flashes	Shutdown Mode
1	Timed out
2	Over-rev shutdown
3	Low or no RPM
4	Transmitter shutdown (or optional push button)
5	(+) Brake shutdown (H3/3 BROWN)
6	(-) Hoodpin (H3/4 GRAY)
7	(-) Neutral safety shutdown (H3/1 BLACK/WHITE)
8	Wait-to-start timed out

Safety check

Before vehicle reassembly, the remote start system must be checked to ensure safe and trouble-free operation. The following test procedure must be used to verify proper installation and operation of the system. The installation must be completed before testing, including connection to the brake switch and hood switch.

1. Test the BRAKE shutdown circuit: With the vehicle in Park (P), activate the remote start system. Once the engine is running, press the brake pedal. The engine should shut down immediately. If the engine continues to run, check the brake circuit connection.
2. Test the HOOD PIN shutdown circuit: With the vehicle in Park (P), open the hood. Activate the remote start system. The vehicle should not start. If the starter engages, check your hood pin and connections.
3. Test the NEUTRAL SAFETY shutdown circuit.

<p>Important: Make sure there is adequate clearance to the front and rear of the vehicle before attempting this test.</p>
--

4. Make sure the hood is closed and no other shutdown circuits are active.
 5. Set the emergency brake.
 6. Turn the ignition key to run position but do not start the engine.
 7. Put the vehicle in Drive (D).
 8. Put your foot over the brake pedal but do not press down on it. Be ready to step on the brake to shutdown the remote start system.
 9. Activate the remote start system.
- If the starter engages, immediately step on the brake to shut down the system. If it does engage, recheck the neutral safety input connection. The vehicle may use a mechanical neutral safety switch. (See H3/1 BLACK/WHITE neutral safety switch input in Remote Start Harness Wire Connection Guide section of this guide.)
 - If the starter does not engage, the test is complete. Once the system passes the tests, the vehicle can be re-assembled and delivered. Do not use the remote start system or finalize the installation if it fails any of the safety check tests.

► Alarm

- **Shock sensor doesn't trigger the alarm:**

Has the NPC system been triggered? If so, you will hear 5 chirps when disarming. To check this, turn the ignition key on and off to clear the NPC's memory, and then retest the shock sensor. For a detailed description of NPC, see Nuisance Prevention® Circuitry section of the Owner's Guide.

- **Door input does not immediately trigger full alarm. Instead chirps are heard for the first 3 sec**

That's how the progressive two-stage door input works! This is a feature of this system. This is an instant trigger, remember, since even if the door is instantly closed again, the progression from chirps to constant siren will continue.

- **Closing the door triggers the system, but opening the door does not:**

Have you correctly identified the type of door switch system? This happens often when the wrong door input has been used. (See Primary Harness Wire Connection Guide section of this guide.)

- **System does not passively arm until it is remotely armed and then disarmed:**

Are the door inputs connected? Is the H1/6 blue wire connected to the door trigger wire in the vehicle? Either the H1/5 green or the H1/7 violet should be used instead. (See wiring diagrams.)

- **Door input does not respond with the progressive trigger, but with immediate full alarm:**

Does the Status LED indicate that the trigger was caused by the shock sensor? (See Diagnostics section of this guide.) The shock sensor, if set to extreme sensitivity, may be detecting the door unlatching before the door switch sends its signal. Reducing the sensitivity can solve this problem.

- **The Valet/Program switch doesn't work.**

Is it plugged into the correct socket? See Plug-In LED and Valet/Program Switch section of this guide.

- **Status LED doesn't work.**

You've probably guessed already, but here goes: Is it plugged in? (See Plug-In LED and Valet/Program Switch section of this guide.) Is the LED plugged into the correct socket?

- **Door locks operate backwards.**

This unit has easily-reversed lock/unlock outputs. Recheck wire connections to see if you have reversed these.

➤ Remote start

- **The remote start will not activate**

1. Check the harnesses and their connections. Make sure that the harnesses are completely plugged into the remote start module. Make sure there are good connections to the vehicle wiring.
2. Check voltage and fuses on the main 12-pin harness and on the heavy gauge remote start harness.
3. Check diagnostics. The diagnostics will tell you which shutdown is active or not connected.

- **The remote start will activate, but the starter never engages.**

1. Check for voltage on the purple starter wire two seconds after the remote start becomes active. If there is voltage present, skip to Step 4. If there is not voltage present, advance to Step 2.
2. Check the 30A fuses.
3. If the gray/black wait-to-start wire is detecting ground upon activation, the starter will not crank.
4. Make sure the purple starter wire is connected on the starter side of the optional starter kill/anti-grind relay.
5. Does the vehicle have an immobilizer? Some immobilizer systems will not allow the vehicle to crank if active.
6. Check connections. The heavy gauge remote start input wires on the heavy gauge 10-pin connector should have a solid connection. "T-taps" or "scotch locks" are not recommended for any high current heavy gauge wiring.

- **The vehicle starts, but immediately dies.**
 1. Does the vehicle have an immobilizer? The vehicle's immobilizer will cut the fuel and/or spark during unauthorized starting attempts.
 2. Is the remote start programmed for voltage sense? If so, the crank time may not be set high enough. Voltage sense will not work on some vehicles.
 3. Check diagnostics. Sometimes a shutdown will become active during cranking or just after cranking.

- **The vehicle starts, but the starter keeps running.**
 1. Is the system programmed for engine checking off or voltage sense? When programmed for either of these features, the engine cranks for the pre programmed crank time regardless of how long it takes for the vehicle to actually start. Adjust to a lower cranking time.
 2. Was the Tach Learn successful? The LED must light solid and bright to indicate a successful learn.
 3. Make sure that there is a tach signal at the purple/white tach input wire of the remote start. If there is not a tach signal, recheck the connection to the vehicle's tach wire and make sure the wire is not broken or shorted to ground leading to the remote start.

- **The vehicle starts, but will only run for 10 seconds.**
 1. Is the remote start programmed for voltage sense? If this does not work, a tach wire should be used.
 2. Check shutdown diagnostics.

- **The climate control system does not work while the unit is operating the vehicle.**

Either the wrong accessory wire is being energized or more than one ignition or accessory wire must be energized in order to operate the climate control system.

Wiring quick reference guide

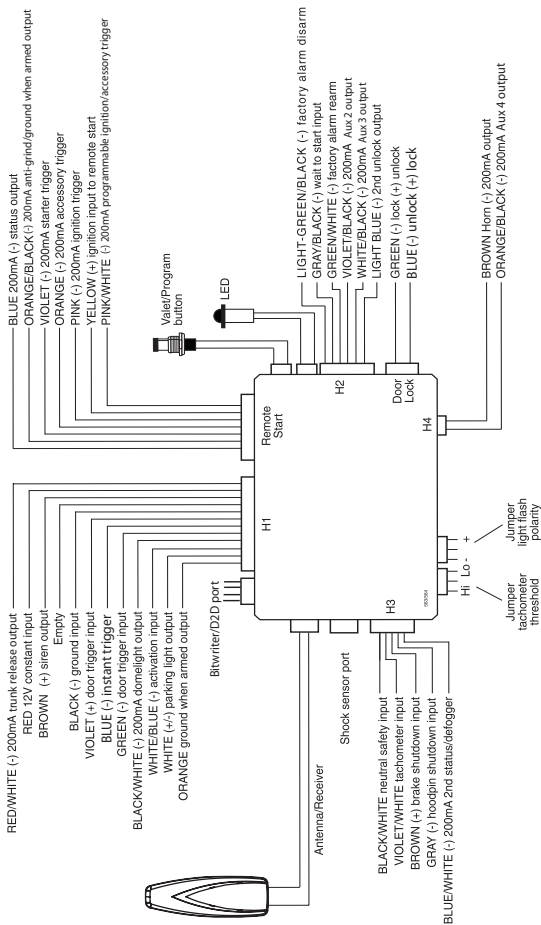

Relay satellite wiring quick reference guide

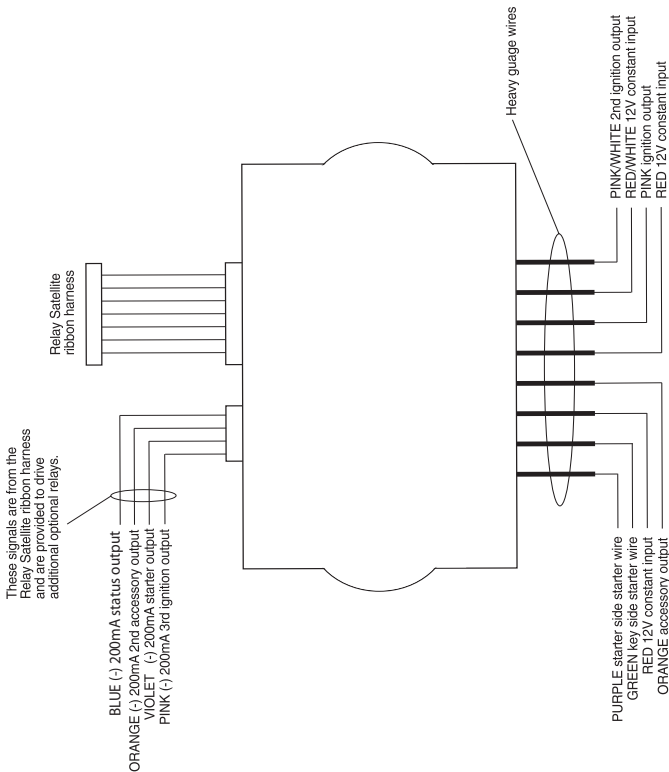

The company behind this system is Directed Electronics

Since its inception, Directed Electronics has had one purpose, to provide consumers with the finest vehicle security and car stereo products and accessories available. The recipient of nearly 100 patents and Innovations Awards in the field of advanced electronic technology, Directed is ISO 9001 registered.

Quality Directed Electronics products are sold and serviced throughout North America and around the world.

Call (800) 274-0200 for more information about our products and services.



Directed Electronics is an ISO 9001 registered company.

Directed Electronics is committed to delivering world class quality products and services that excite and delight our customers.

Directed[®]
E L E C T R O N I C S

N5103L 2009-07

Vista, CA 92081

www.directed.com

© 2009 Directed Electronics—All rights reserved